

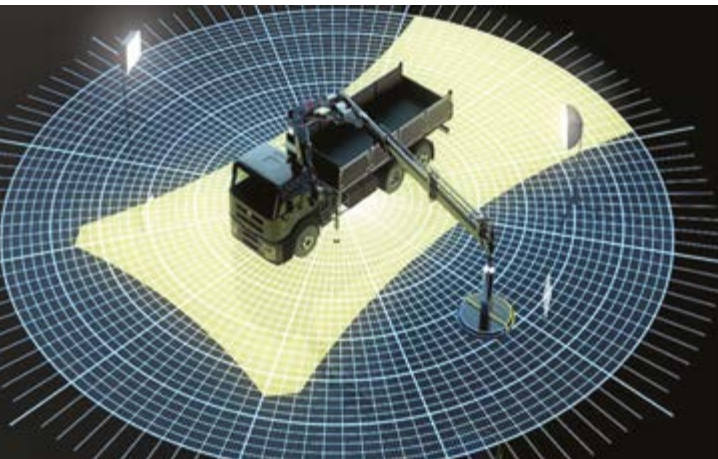

**105 D**

# 105 D



### Variable Stability Logic - VSL

The optional VSL function is a safety system that maximises capacity by calculating the stability according to the position of the stabilizer legs and the total weight of the truck. By accounting for the true load, it can provide significantly more lifting capacity when it really matters.

### Variable Stability Logic - VSL

*La funzione opzionale VSL rappresenta un sistema di sicurezza che massimizza le performance calcolando la stabilità in base alla posizione degli stabilizzatori e al peso totale del camion.*

*Considerando il carico reale, può fornire una capacità di sollevamento significativamente maggiore nel momento giusto.*



### Semi Automatic Folding - SAF

The optional SAF function is key to making your business efficient, while saving time and increasing the overall safety of the repetitive operations. SAF allows drivers to open and close the crane with the touch of one single lever of the remote control.

- Reduce risk of damages
- Reduce operator stress during repetitive cycles
- Save time for folding and unfolding

### Semi Automatic Folding - SAF

*La funzione opzionale SAF è la chiave per rendere efficiente il tuo lavoro, risparmiando tempo e aumentando la sicurezza generale delle operazioni ripetitive con la gru. SAF consente all'operatore di aprire e chiudere la gru con il tocco di una sola leva del radiocomando.*

- Riduce il rischio di danni
- Riduce lo stress dell'operatore durante i cicli ripetitivi
- Risparmia tempo per aprire e chiudere la gru



The control system of the D models represents a perfect balance between performance and price, with its modern features and functions it delivers safe and efficient handling of the crane. Drivers appreciate the remote control and the precise and fast movements they can do, while reducing potential worksite and equipment damage.

*Il sistema di controllo dei modelli D rappresenta un perfetto equilibrio tra prestazioni e prezzo, con le sue caratteristiche e funzioni aggiornate garantisce una movimentazione sicura ed efficiente dei carichi. Gli operatori apprezzano il radiocomando che permette movimenti precisi e veloci, riducendo così anche i potenziali danni all'ambiente circostante e alle apparecchiature.*

### EFFER 105D BS-1

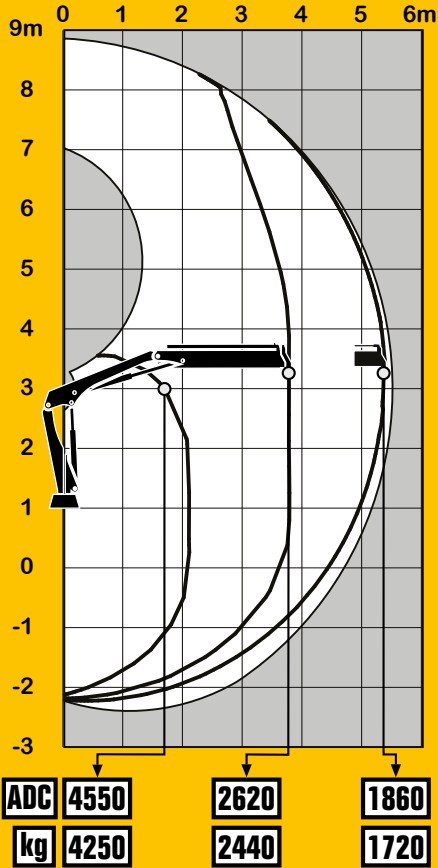

459 3865

### EFFER 105D BS-2

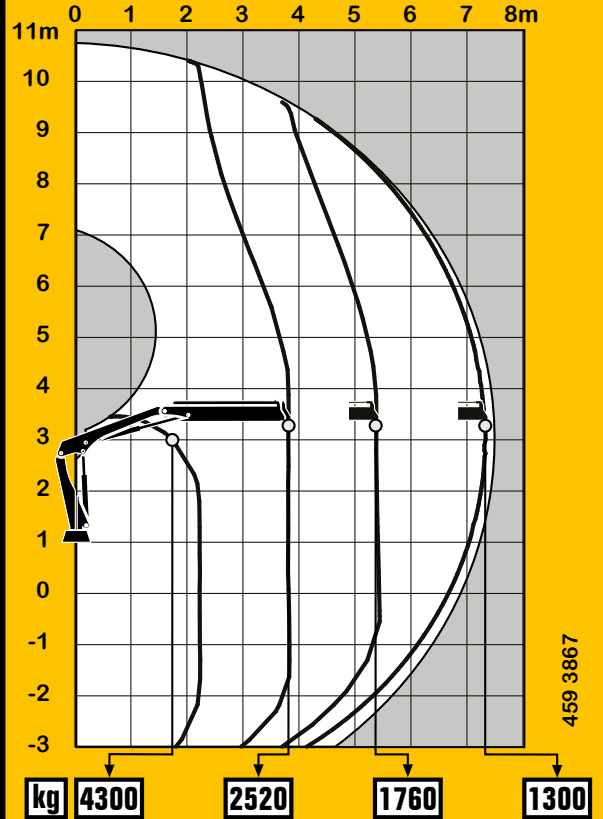

459 3867

### EFFER 105D B-3

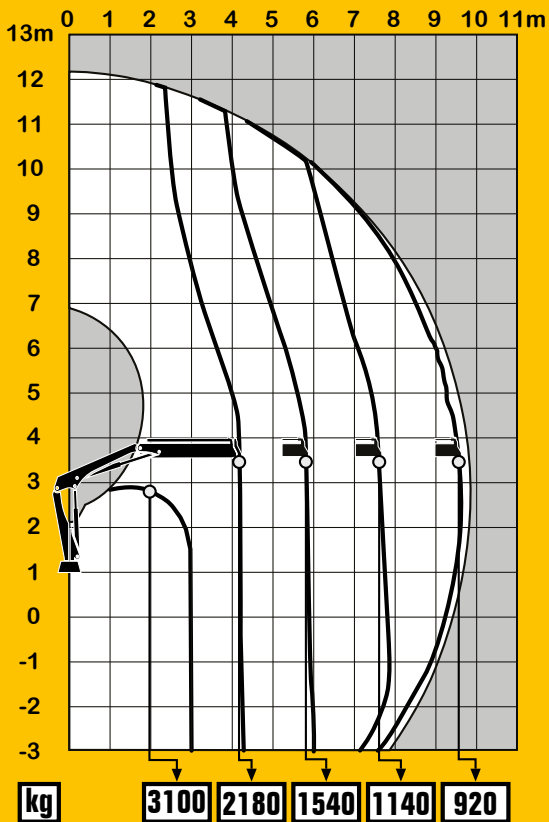

459 3863

### EFFER 105D E-4

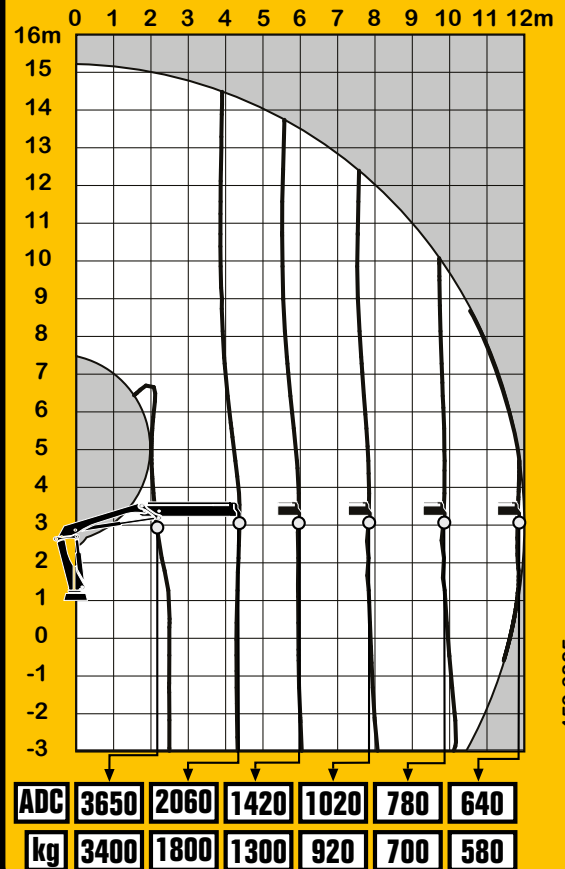

459 3885



# EFFER 105D E-2

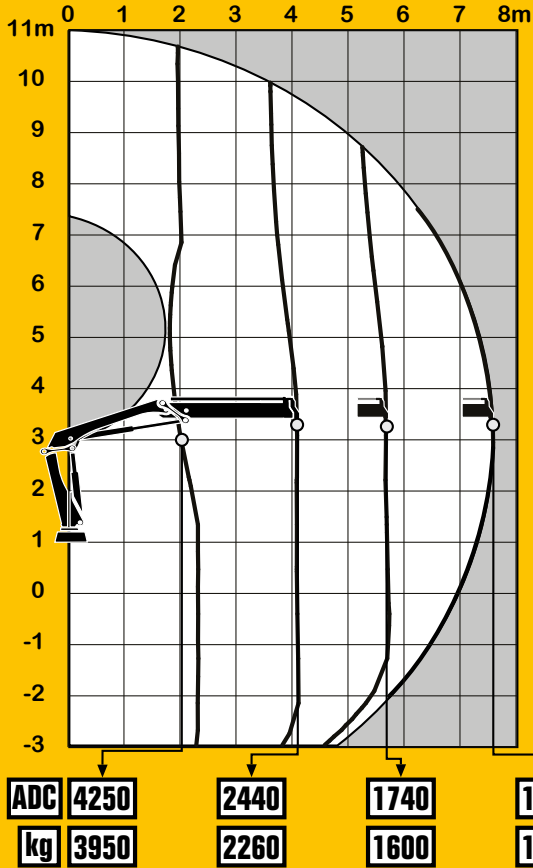

# EFFER 105D E-3

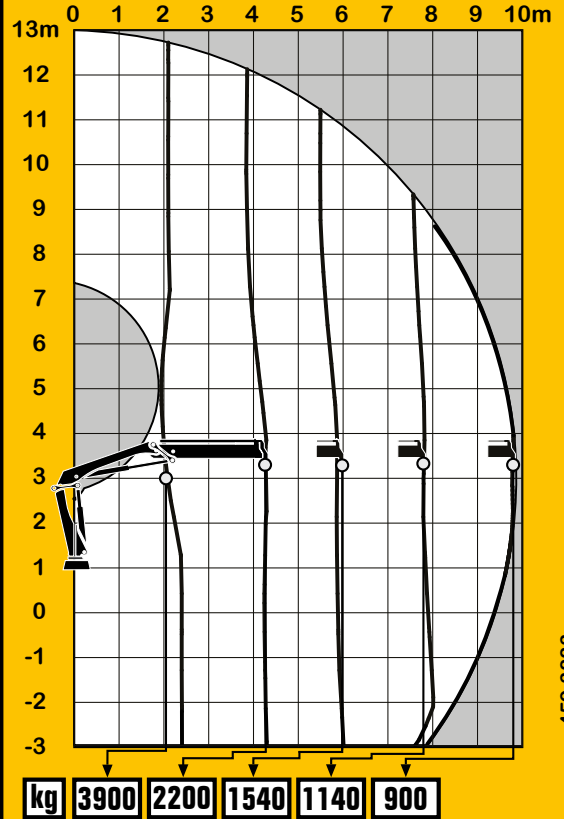

# EFFER 105D ES-5

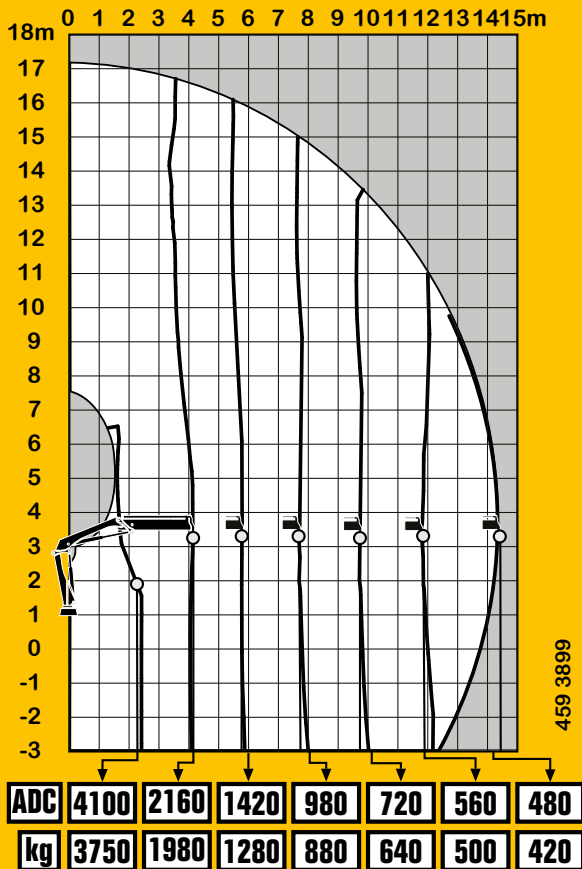

# EFFER 105D E-5

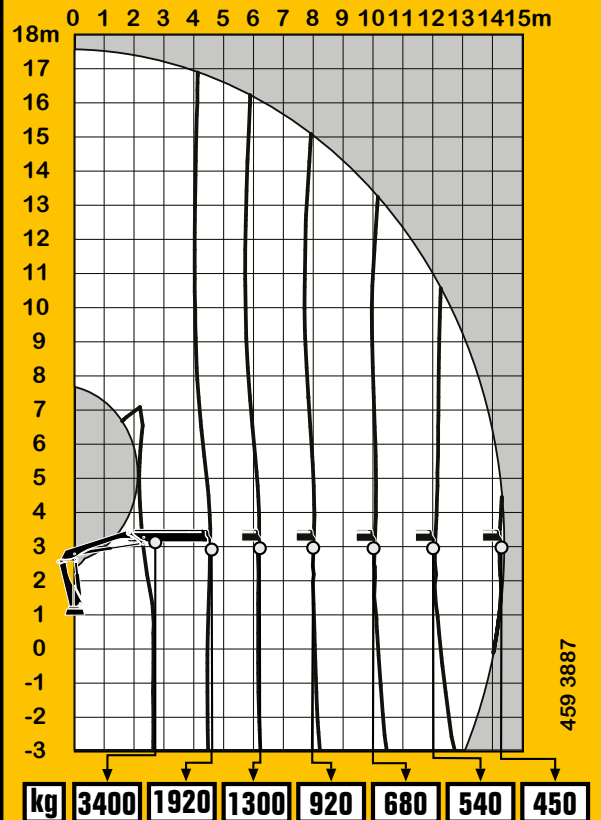

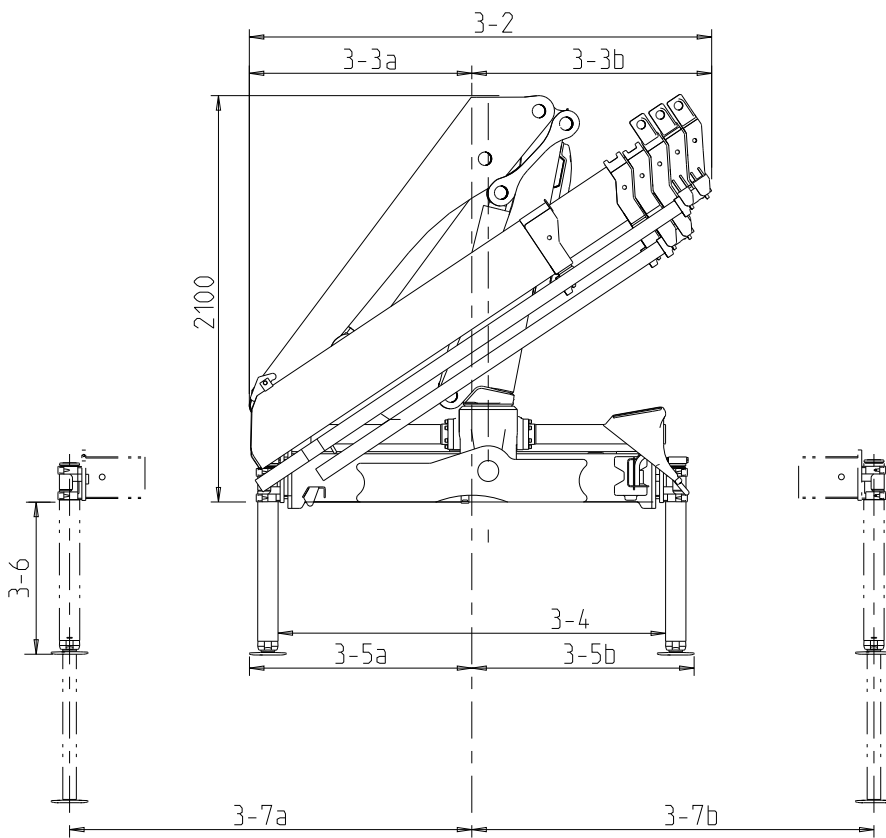

Base		2300	2500	Stab. ext.
Hydraulic stabiliser extension	3-4	2060	2200	
	3-5a/b	1180*	1250	
	3-6	450		S
		655		M
		765		L
	3-7a/b	1695	1765	S
		2345	2415	M
		-	2685	L

\* Exceeds 2300 base width

HYDRAULIC EXTENSION	UNIT OF MEASURE	BS-1	BS-2	E-2	E-3	B-3	E-4	ES-5	E-5
3-2	mm	2135	2225	2105	2295	2280	2300	2400	2400
3-3a	mm	995	1085	955	990	1140	1150	1250	1250
3-3b	mm	1140	1140	1150	1145	1140	1150	1150	1150

DESCRIPTION	UNIT OF MEASURE	BS-1	BS-2	E-2	E-3	B-3	E-4	ES-5	E-5
Max. lifting moment (+20°) <i>Momento massimo di sollevamento (+20°)</i>	kgm	10000	9600	10000	9500	9200	9100	8900	8700
	kNm	98	94	98	93	90	89	87	85
Slewing arc <i>Angolo di rotazione</i>	(°)	406							
Slewing Capacity - Max slope <i>Capacità di rotazione - Massima pendenza</i>	%	10.5							
Recommended oil delivery <i>Portata d'olio consigliata</i>	l/min	45-55							
Oil tank capacity <i>Capacità serbatoio olio</i>	l	0-120							
Weight of the standard crane (± 2%) <i>Peso gru standard (± 2%)</i>	kg	1020	1130	1200	1300	1230	1480	1560	1580
Weight of the stabiliser extension <i>Peso stabilizzatori</i>	kg	156-300							



### At your service, always and everywhere

When you invest in EFFER equipment, you invest in quality performance to safely and efficiently fulfill your commitments to your customers. To extend the service life of your product and ensure maximum safety, maintenance and regular interventions are fundamental. EFFER's dealers are certified partners present all over the world to support you with these services or help you in any case of need. With the latest tools, connectivity and a wide network of experts, we can support you whenever and wherever you need us.

### Al tuo servizio, sempre e ovunque

Quando investi in una gru EFFER, investi in prestazioni di qualità per adempiere in modo sicuro ed efficiente ai tuoi impegni nei confronti dei tuoi clienti. Per prolungare la vita utile della tua macchina e garantire la massima sicurezza, manutenzione e controlli regolari sono fondamentali. I rivenditori EFFER sono partner certificati presenti in tutto il mondo per supportarti con questi servizi o aiutarti per qualsiasi tua necessità. Con le tecnologie più avanzate, la connettività e un'ampia rete di esperti, possiamo supportarti quando e dove hai bisogno di noi.

### Keep your EFFER an EFFER with original spare parts

EFFER Original Spare Parts are tested and certified according to the same standards used for making a brand new crane guaranteeing durability and reliability over the years to come. The key to maintain the best performance and add durability to your product is by using EFFER Original Spare Parts.

Each and every part of an EFFER crane makes it even more an EFFER. Choose to keep it performing at its highest level, using only EFFER Original Spare Parts which guarantee perfect fit and the quality necessary to always perform at the top.

### Mantieni la tua EFFER una EFFER con i ricambi originali

I Ricambi Originali EFFER sono testati e certificati secondo gli stessi standard utilizzati per la realizzazione di una gru garantendo durata e affidabilità negli anni a venire. La chiave per mantenere le migliori prestazioni e aumentare la durata della tua macchina è l'utilizzo di ricambi originali EFFER.

Ogni parte di una gru EFFER la rende ancora più una EFFER. Scegli di mantenerla performante ai massimi livelli utilizzando solo Ricambi Originali EFFER che garantiscono una perfetta adattabilità e la qualità necessaria perché la tua gru sia sempre al top.



### Accessories

Discover a wide range of accessories that make your EFFER crane the right crane for your business and work activity. There are many items to choose among, the high quality and the perfect design make them a perfect match to this range of models.

### Accessori

Scopri una vasta gamma di accessori che renderanno la tua gru EFFER la gru giusta per la tua attività e il tuo lavoro. Ci sono molti articoli tra cui scegliere, l'alta qualità e il design studiato nel dettaglio li rendono perfetti per questa gamma di modelli.



#### CRANE DESIGNED ACCORDING TO STANDARDS UNI EN 12999 HC1 S2 HD4

The configurations and figures contained in the brochure are illustrative. For information on the complete offer and for more technical details, ask your EFFER dealer or consult the website [www.effer.com](http://www.effer.com). The above data are subject to change. Lifting capacity is based on the maximum lifting power of the crane. The stability of the truck may require a reduction of lifting capacity.

Hiab is the world's leading provider of on-road load handling equipment, intelligent services, smart and connected solutions. Hiab's class-leading load handling equipment includes HIAB, EFFER and ARGOS loader cranes, LOGLIFT and JONSERED forestry and recycling cranes, MOFFETT and PRINCETON truck mounted forklifts, MULTILIFT skiploaders and hooklifts, and tail lifts under the ZEPRO, DEL, and WALTCO brands. As the industry pioneer and with a proud 75 year history, Hiab is committed to be the preferred partner and solution provider to its customers and shape the future of intelligent load handling. [www.hiab.com](http://www.hiab.com)  
Hiab is part of Cargotec Corporation. [www.cargotec.com](http://www.cargotec.com)

EFFER S.p.A.

Via IV Novembre, 12 | 40061 Minerbio (BO) Italy

Tel. +39 051 4181211 | [contact@effer.com](mailto:contact@effer.com)

[www.effer.com](http://www.effer.com) | [www.effermarine.com](http://www.effermarine.com)

EFFER is part of HIAB

